



## Palettenregale



### SYSTEM ESNOVA

- ab Lager FOCO bis Regalhöhe 5,0 m lieferbar
- ideal für Belastungen bis 1000 kg/ Palette
- individuell verstellbare Längsträger
- Rahmenfachwerk verzinkt
- alle restlichen Teile pulverbeschichtet



FOCO Lager- und Fördertechnik AG 4147 Aesch  
Telefon 061/756 26 00 — Telefax 061/756 26 56  
E-mail: [info@foco.ch](mailto:info@foco.ch) — Internet: [www.foco.ch](http://www.foco.ch)

- Beratung
- Montage
- Planung
- Wartung

## System Palettenregal

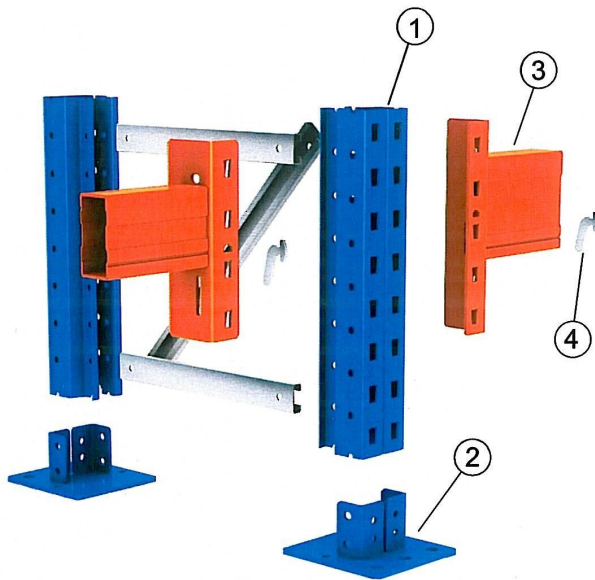

### ① Stütze ER

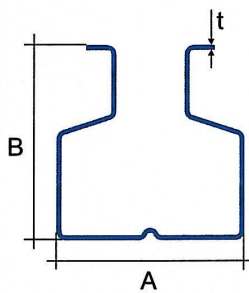

### ② Fussplatte (mm)

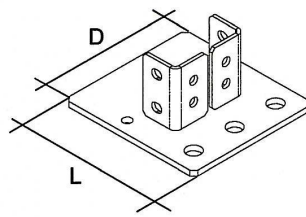

\*Abmessung in mm

Beschreibung	Abmessung* (A x B x t)	Profil	Basis
ER76A15	76 x 79 x 1,5	CZ36	RK6/76/5019
ER76A18	76 x 79 x 1,8		RK8/76/5019
ER76A23	76 x 79 x 2,3		
ER100A18	100 x 81 x 1,8	CZ42	RK6/100/5019
ER100A23	100 x 81 x 2,3		RK8/100/5019
ER100B18	100 x 105 x 1,8		
ER100B23	100 x 105 x 2,3		
ER100B30	100 x 105 x 3		
ER115A30	115 x 126,3 x 3		CZ50

Standard Farbe

ERZ76A20	76 x 79 x 2	CZ36	RK6/76
ERZ76A25	76 x 79 x 2,5		RK8/76

Tiefen (mm)

\*Standard Tiefen

### ③ Längsträger EGN

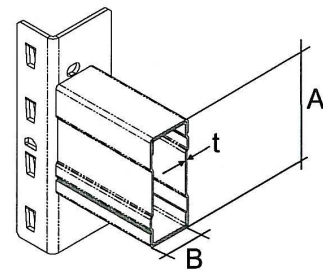
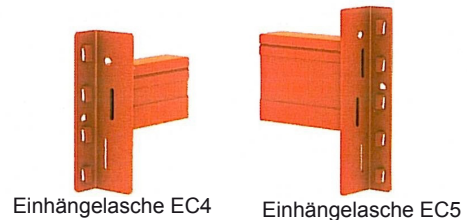

### ④ Sicherungsstift







Beschreibung	Abmessung* (A x B x t)	Anschluss	Länge in mm
EGN 80x40x1,5	80 x 40 x 1,5	EC4	950-1350-1825-2250-2700
EGN 85x40x1,5	85 x 40 x 1,5	EC4	1825-2250-2700
EGN 100x40x1,5	100 x 40 x 1,5	EC4	1825-2250-2700
EGN 100x50x1,5	100 x 50 x 1,5	EC4	1825-2250-2700
EGN 120x40x1,5	120 x 40 x 1,5	EC5	1825-2250-2700
EGN 120x50x1,5	120 x 50 x 1,5	EC5	2250-2700-3300-3600
EGN 135x50x1,5	135 x 50 x 1,5	EC5	2700-3300-3600
EGN 140x50x1,5	140 x 50 x 1,5	EC5	2700-3300-3600-3900
EGN 140x50x2	140 x 50 x 2	EC5	3300-3600-3900
EGN 150x50x1,5	150 x 50 x 1,5	EC5	3300-3600-3900
EGN 150x50x2	150 x 50 x 2	EC5	3600-3900

\*Abmessungen in mm

Standard Farbe

Andere Teile



FOCO Lager- und Fördertechnik AG 4147 Aesch  
 Telefon 061/756 26 00 — Telefax 061/756 26 56  
 E-mail: [info@foco.ch](mailto:info@foco.ch) — Internet: [www.foco.ch](http://www.foco.ch)

- Beratung
- Montage
- Planung
- Wartung



# Zubehör

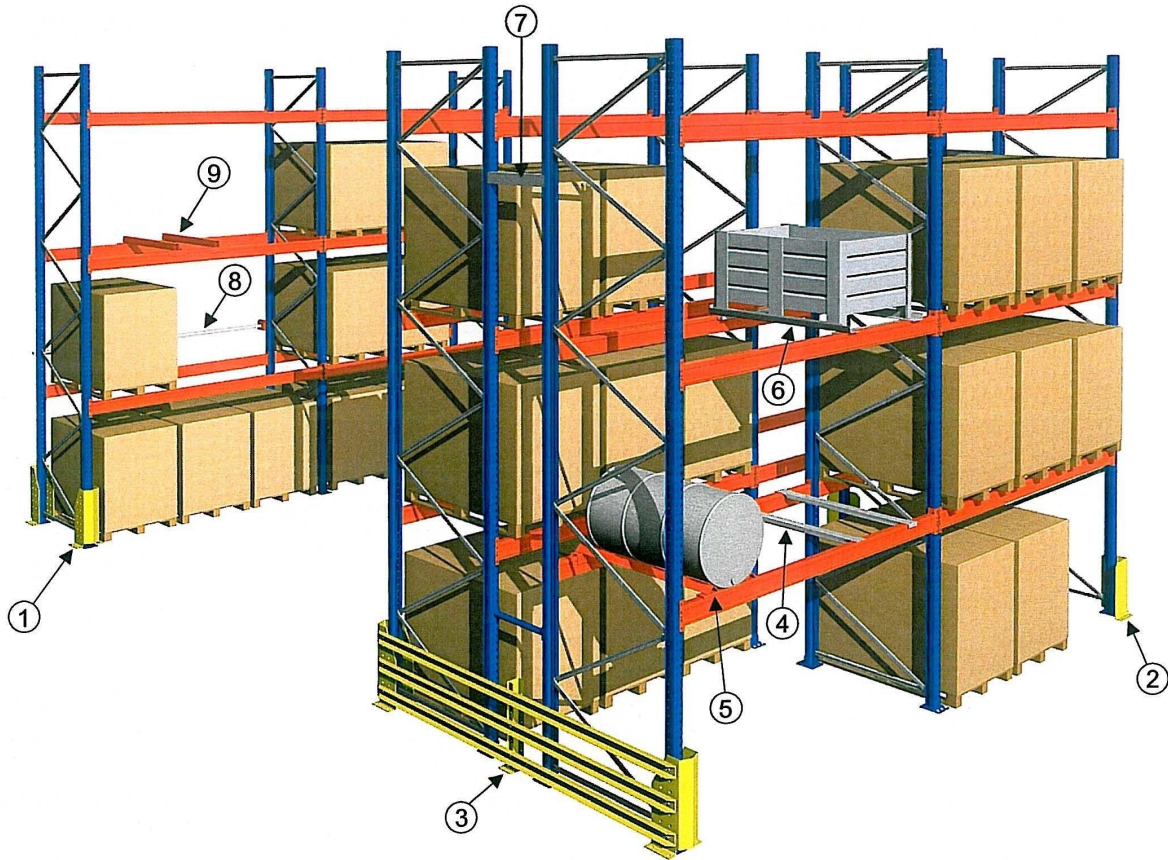

① Stützenschutz RK

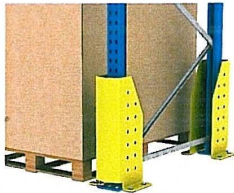

② Eckschutz DE

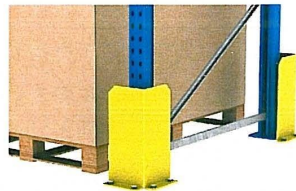

③ Rahmenschutz RK1



④ Tiefenstege TPCZF/TPCZ

Mod: TPCZF

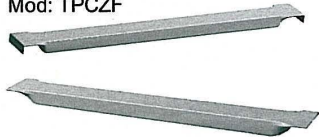

Mod: TPCZ

⑤ Fassauflage SB

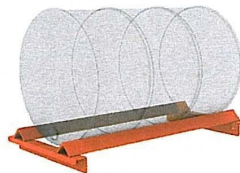

⑥ Containerauflage SC1



⑦ Distanzstücke

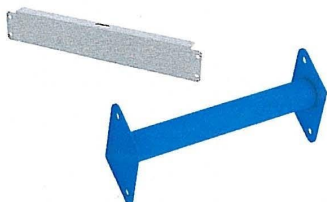

⑧ Durchschubsicherung LTC



⑨ erhöhungstraverse

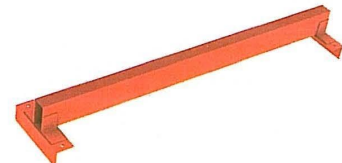



### Stahlpaneele verzinkt

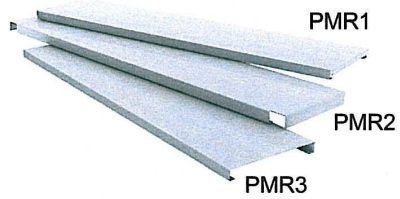

### Rahmenkupplung



### Vertikal Verbände

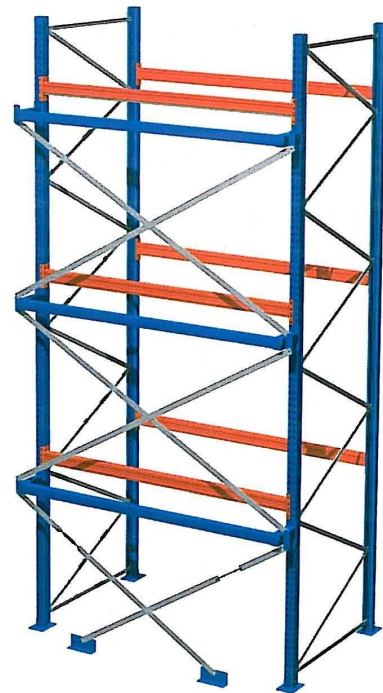

### Horizontal Verbände

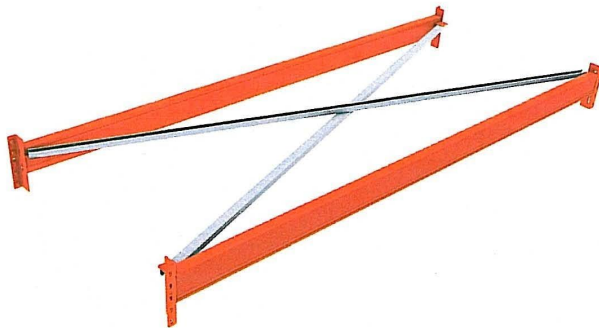

### Gangüberbauung



### Wandhalter

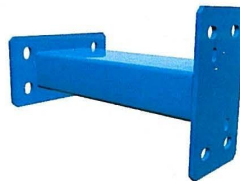

### Bobinenhalter



### Nivellierplatten

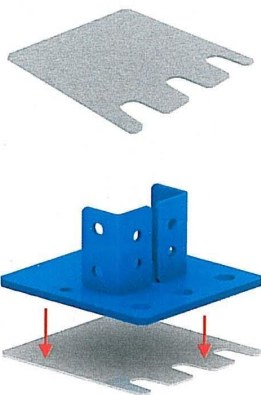

### Spanplatten Anschlag

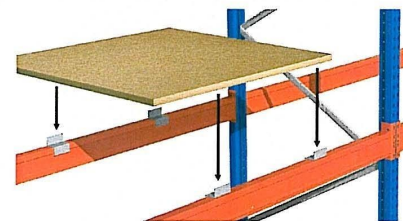

### Spanplatten Anschlag für Tiefenstege

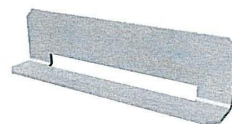



# Auszug aus den Foco-Referenzanlagen

Planung - Lieferung - Montage - Service

## Palettenregale mit 2 Zwischenböden



**Isolier- und Kunststoffe**  
2 x 840 m<sup>2</sup> Lagerfläche  
Ref. Nr. 8343

## Schwerlast-Verschieberegale



**Elektro + Transformatorenindustrie**  
600 Paletten à 5000 kg/PP  
Ref. Nr. 20883

## Verschieberegale im Kühlraum



**Margarine + Ölindustrie**  
580 Paletten à 1000 kg/PP  
Ref. Nr. 12797

## Hochregallager, stationär



**Maschinenindustrie**  
6336 Paletten à 625 kg/PP  
Ref. Nr. 19882

## Durchlaufregale



**Getränkeindustrie**  
1216 Paletten à 1000 kg/PP  
Ref. Nr. 12797

## Verschieberegale



**Spitalarchiv**  
10 fahrbare Archivanlagen

## Automatisches Lager für Langgut



**Kunststoffindustrie**  
58 Schaumstoffblöcke,  
B = 2.2 m, H = 1.2 m, L = 30 m, 5000 kg  
Ref. Nr. 12474

## Einfahrregale Drive-In



**Nahrungsrohstoffe**  
400 BIG BAG Paletten à 1000 kg/PP  
Ref. Nr. 23424

## Automatisches Durchlauflager



**Molkereiprodukte**  
2368 Paletten à 750 kg/PP  
Ref. Nr. 14330